



## Tournament Formats

The following is a list of tournament formats that might come in handy when hosting a tournament. It is design as a tool to assist a first time host and even the more experienced tournament director. We have tried to list more than one format for each possible number of teams, for a successful tournament. These are merely suggestions. Please feel free to call our office if you have any questions.

503.644.7468

<u>No. of teams entered</u>	<u>No. of courts</u>	<u>Pages to use</u>
3-standard	1	1, 2, 3
4-standard	1	6, 7, 8, or 9
5-round robin	1*	10, 12
-standard	2	10, 11, 13 or 14
6-standard	2	1, 3, 15 or 16
-cross pool	2	4, 5, 15 or 16
-dual pool	2	1, 3, 4, 5
7-standard	2	1, 3, 6, 7, 17 or 18
8-standard	2	6, 7, 19 or 20
-dual pool	2	Reseed, 6, 7
-split divisions	2	6, 7, 8 or 9
9-standard	3	1, 3, 21 or 22
-pool rotation (3 pools of 3)	2	1, 3, 21 or 22

<b>10-standard</b>		<b>3</b>
-cross pool (3 team pools)		<b>3</b>
-standard		<b>4</b>
<b>11-standard</b>	<b>3</b>	<b>1, 3, 6, 7, 21 or 22</b>
-power pool	<b>3</b>	<b>4, 5, 6, 7, 21 or 22</b> <b>10, 11, 21 or 22</b>
<b>12-standard</b>	<b>3</b>	<b>1, 3, 6, 7, 21 or 22</b>
-split divisions	<b>3</b>	<b>1, 3, 6, 7, 21 or 22</b>
-standard	<b>4</b>	
-split divisions	<b>4</b>	
<b>13-standard</b>	<b>4</b>	<b>6, 7, 21 or 22</b>
-split divisions	<b>4</b>	<b>6, 7, 15 or 16</b> <b>1, 3, 21 or 22</b> <b>4, 5, 21 or 22</b>
<b>14-standard</b>	<b>4</b>	<b>1, 3, 6, 7, 23 or 24</b>
-split divisions	<b>4</b>	<b>1, 3, 6, 7, 13 or 14, 19 or 20</b>
<b>15-standard</b>	<b>4</b>	<b>1, 3, 6, 7, 23 or 24</b>
-split divisions	<b>4</b>	<b>1, 3, 6, 7, 15 or 16, 19 or 20</b>
<b>16-standard</b>	<b>4</b>	<b>1, 3, 6, 7, 23 or 24</b>
-split divisions	<b>4</b>	<b>1, 3, 6, 7, 17 or 18, 19 or 20</b>
-power playoff	<b>4</b>	
-(all the 1 <sup>st</sup> place teams from pool play in a championship bracket, and all the 2 <sup>nd</sup> 's in a bracket, all the 3 <sup>rd</sup> 's and all the 4 <sup>th</sup> 's.)		<b>6, 7, 23 or 24</b> <b>6, 7, 19 or 20</b> <b>6, 7, 8 or 9</b>

**For more information or larger brackets, please call our office.**

**\*must be approved by the CEVA office**



Division:

Date:

Hosted by:

POOL:

TEAMS	1	2	3	<u>Match</u>		<u>Games</u>		Points	%
				W	L	W	L		
1.	X								
								Total	
2.		X							
								Total	
3.			X						
								Total	





## POOL ASSIGNMENTS

POOL \_\_\_\_ CT \_\_\_\_

1. \_\_\_\_\_

2. \_\_\_\_\_

3. \_\_\_\_\_

POOL \_\_\_\_ CT \_\_\_\_

1. \_\_\_\_\_

2. \_\_\_\_\_

3. \_\_\_\_\_

POOL \_\_\_\_ CT \_\_\_\_

1. \_\_\_\_\_

2. \_\_\_\_\_

3. \_\_\_\_\_

## POOL PLAY SCHEDULE

	PLAY	REF
8:30	2-3	1
9:45	1-3	2
11:00	1-2	3

Pool play matches will be best 2 out of 3 sets.

Sets 1&2 are rally scoring to 25 points.

Set 3 is rally scoring to 15 points, switch sides at 8 points.

For all games: There is no cap! Win by 2 points.

Bracket play will start at approximately \_\_\_\_



## POOL ASSIGNMENTS

POOL \_\_\_\_ CT \_\_\_\_

A. \_\_\_\_\_

B. \_\_\_\_\_

C. \_\_\_\_\_

POOL \_\_\_\_ CT \_\_\_\_

1. \_\_\_\_\_

2. \_\_\_\_\_

3. \_\_\_\_\_

## POOL PLAY SCHEDULE

Court 1			Court 2		
PLAY	REF		PLAY	REF	
A-1	C	8:30	B-2	3	
B-3	2	9:25	C-1	A	
C-3	B	10:20	A-2	1	
A-3	2	11:15	B-1	C	
C-2	A	12:10			

POOL PLAY WILL BE 3 GAMES TO 25 POINTS  
NO CAP WIN BY 2 POINTS





**Division:**  
**Date:**  
**Hosted by:**

**POOL:**

TEAMS	1	2	3	4	<u>Match</u>		<u>Games</u>		<u>Points</u>		%
					W	L	W	L			
1.	X										
										Total	
2.		X									
										Total	
3.			X								
										Total	
4.				X							
										Total	



## POOL ASSIGNMENTS

POOL \_\_\_\_ CT \_\_\_\_

1. \_\_\_\_\_
2. \_\_\_\_\_
3. \_\_\_\_\_
4. \_\_\_\_\_

POOL \_\_\_\_ CT \_\_\_\_

1. \_\_\_\_\_
2. \_\_\_\_\_
3. \_\_\_\_\_
4. \_\_\_\_\_

POOL \_\_\_\_ CT \_\_\_\_

1. \_\_\_\_\_
2. \_\_\_\_\_
3. \_\_\_\_\_
4. \_\_\_\_\_

## POOL PLAY SCHEDULE

	<b>PLAY</b>	<b>REF</b>
8:00	2-3	4
9:00	1-4	3
10:00	2-4	1
11:00	1-3	4
12:00	3-4	2
1:00	1-2	3

Pool play matches will be best 2 out of 3 sets.

Sets 1&2 are rally scoring to 25 points.

Set 3 is rally scoring to 15 points, switch sides at 8 points.

For all games: There is no cap! Win by 2 points.

The second wave of pool play will start at approximately \_\_\_\_

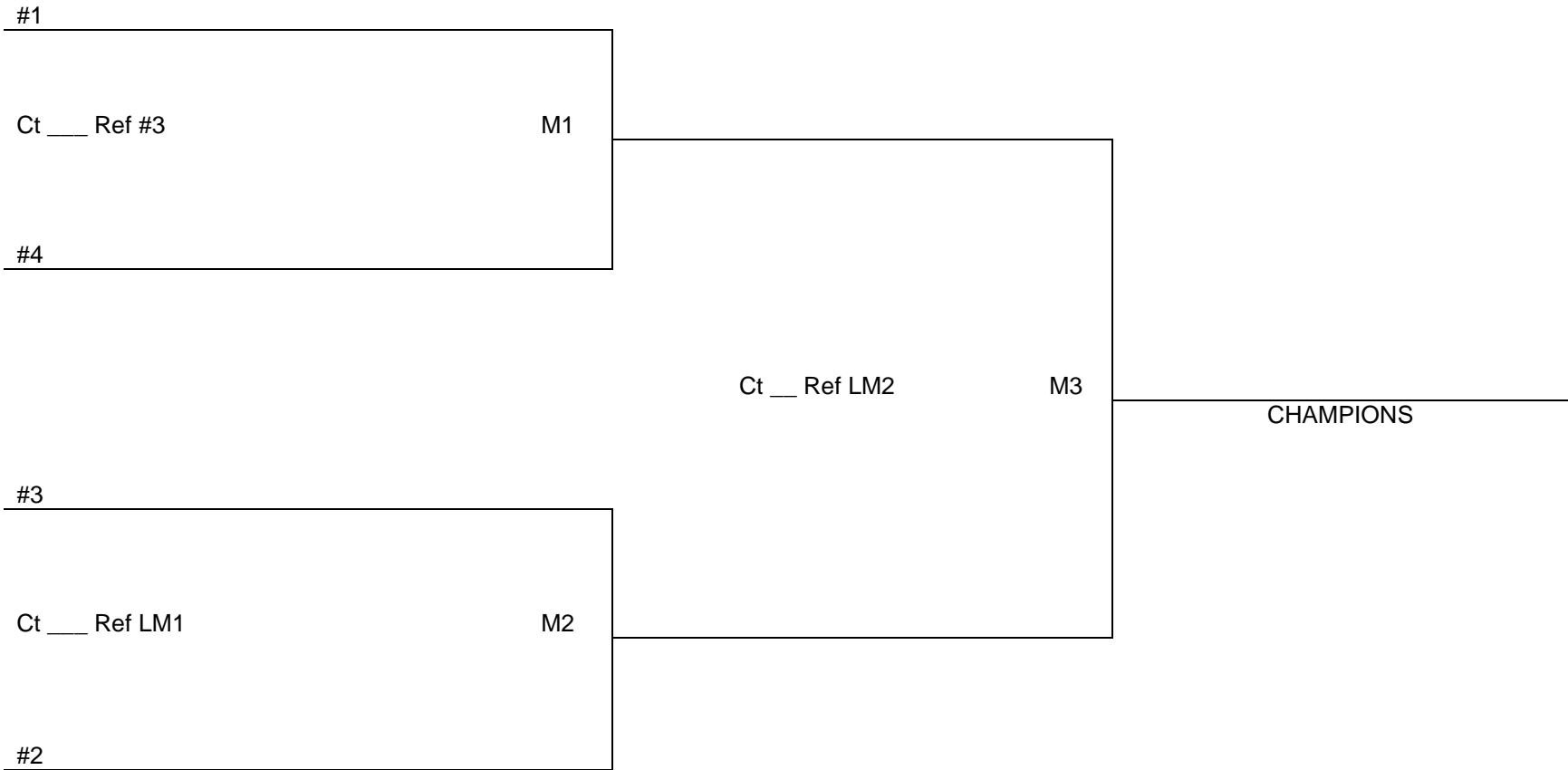

Matches will be : Best 2 out of 3  
Sets 1&2: to 25 points  
Set 3: to 15-switch side at 8

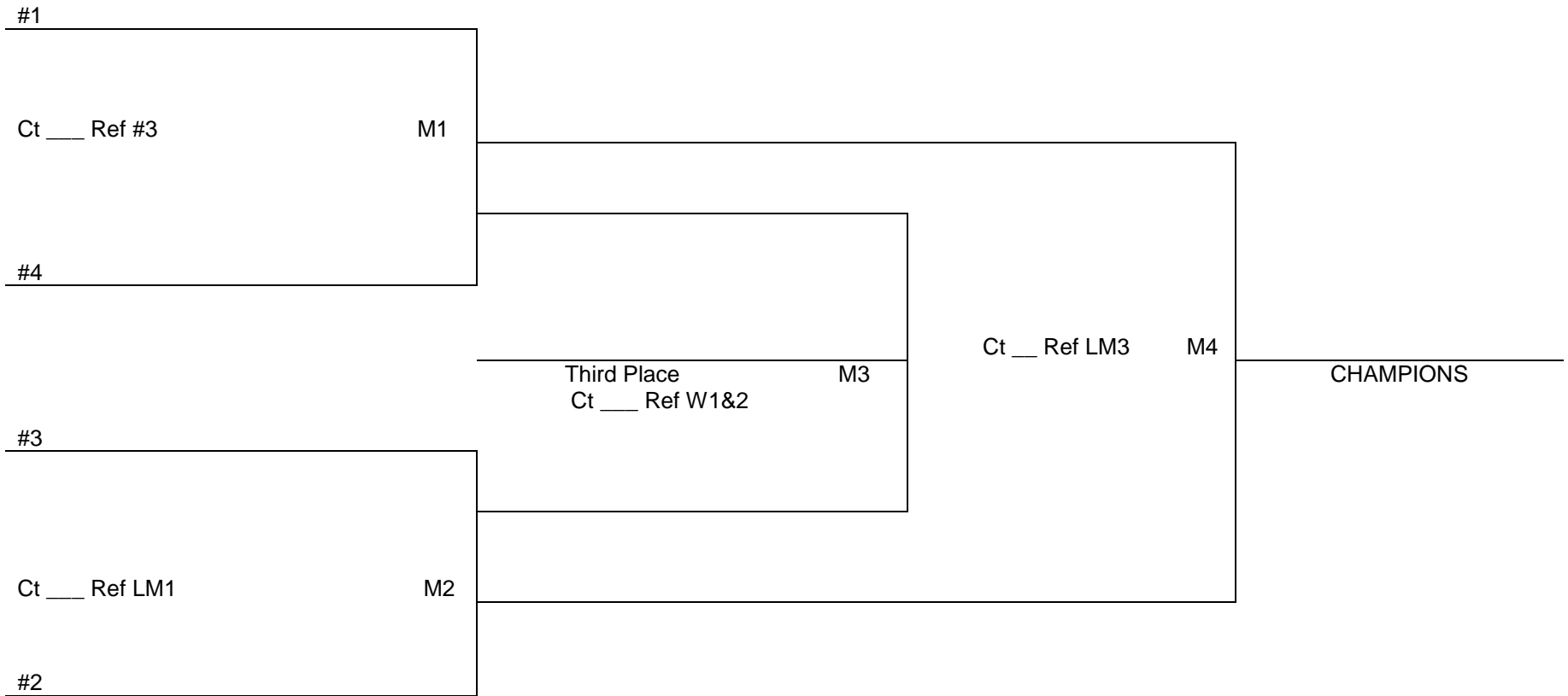

Matches will be : Best 2 out of 3  
Sets 1&2: to 25 points  
Set 3: to 15-switch side at 8



Division:  
Date:  
Hosted by:

**POOL:**

Teams	1	2	3	4	5	<u>Match</u>		<u>Games</u>		<u>Points</u>			<u>%</u>
						W	L	W	L				
1.	X												
										Total:			
2.		X											
										Total:			
3.			X										
										Total:			
4.				X									
										Total:			
5.					X								
										Total:			



## POOL ASSIGNMENTS

Courts \_\_\_\_\_ & \_\_\_\_\_

POOL

1. \_\_\_\_\_
2. \_\_\_\_\_
3. \_\_\_\_\_
4. \_\_\_\_\_
5. \_\_\_\_\_

## POOL PLAY SCHEDULE

	PLAY	REF
8:30	1-4/2-5	3
9:20	2-4/3-5	1
10:10	1-3/4-5	2
11:00	1-5/2-3	4
11:50	1-2/3-4	5

Pool play matches will be best 2 out of 3 sets.

Set 1 & 2 are rally scoring to 25 points.

Set 3 is rally scoring to 15 points, switch sides at 8 points.

For all Games: There is no cap! Win by 2 points.

Bracket Play will start at approximately \_\_\_\_\_



POOL ASSIGNMENT: Court \_\_\_\_\_

1. \_\_\_\_\_
2. \_\_\_\_\_
3. \_\_\_\_\_
4. \_\_\_\_\_
5. \_\_\_\_\_

### POOL PLAY SCHEDULE

	<b>Play</b>	<b>Ref</b>		<b>Play</b>	<b>Ref</b>
8:30	2-4	3	12:40	1-2	3
9:20	1-3	5	1:30	4-5	1
10:10	2-5	1	2:20	2-3	4
11:00	1-4	2	3:10	1-5	2
11:50	3-5	4	4:00	3-4	5

Pool play matches will be best 2 out of 3 sets.

Set 1 & 2 are rally scoring to 25 points.

Set 3 is rally scoring to 15 points, switch sides at 8 points.

For all Games: There is no cap! Win by 2 points.

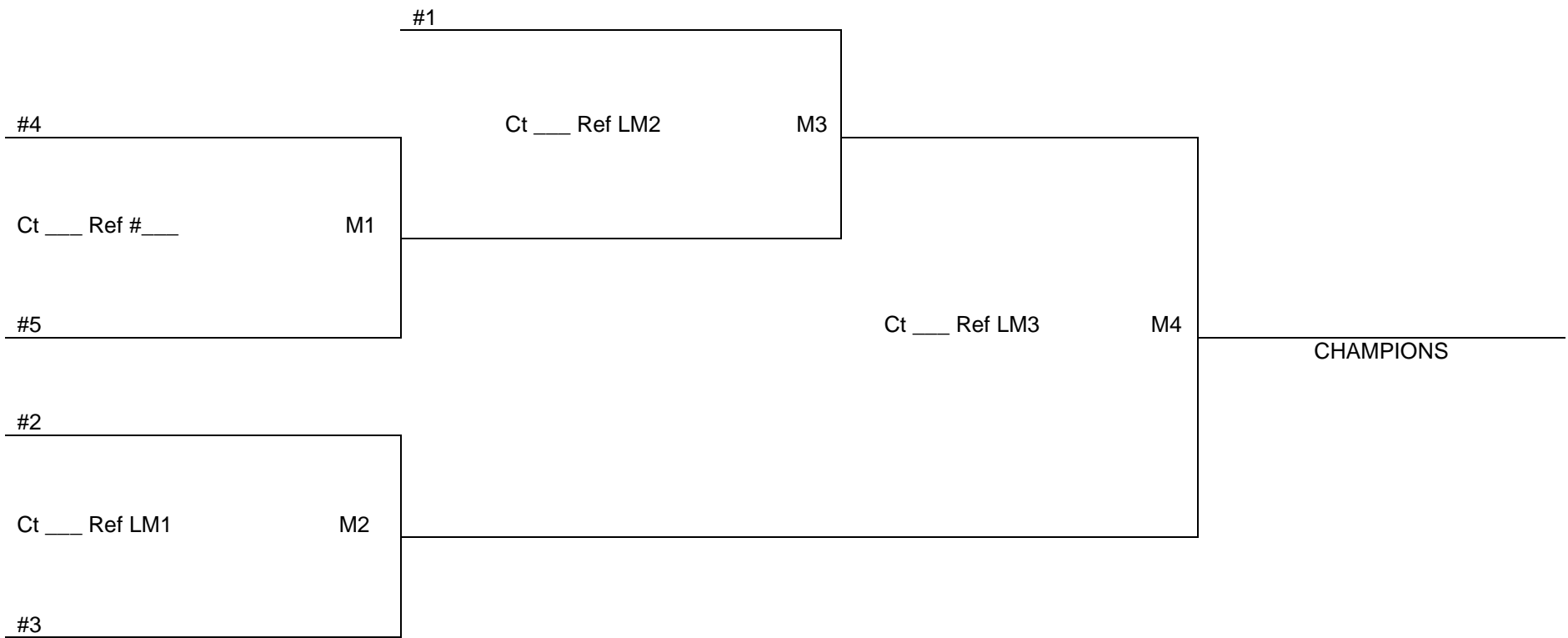

Matches will be : Best 2 out of 3  
Sets 1&2: to 25 points  
Set 3: to 15-switch side at 8

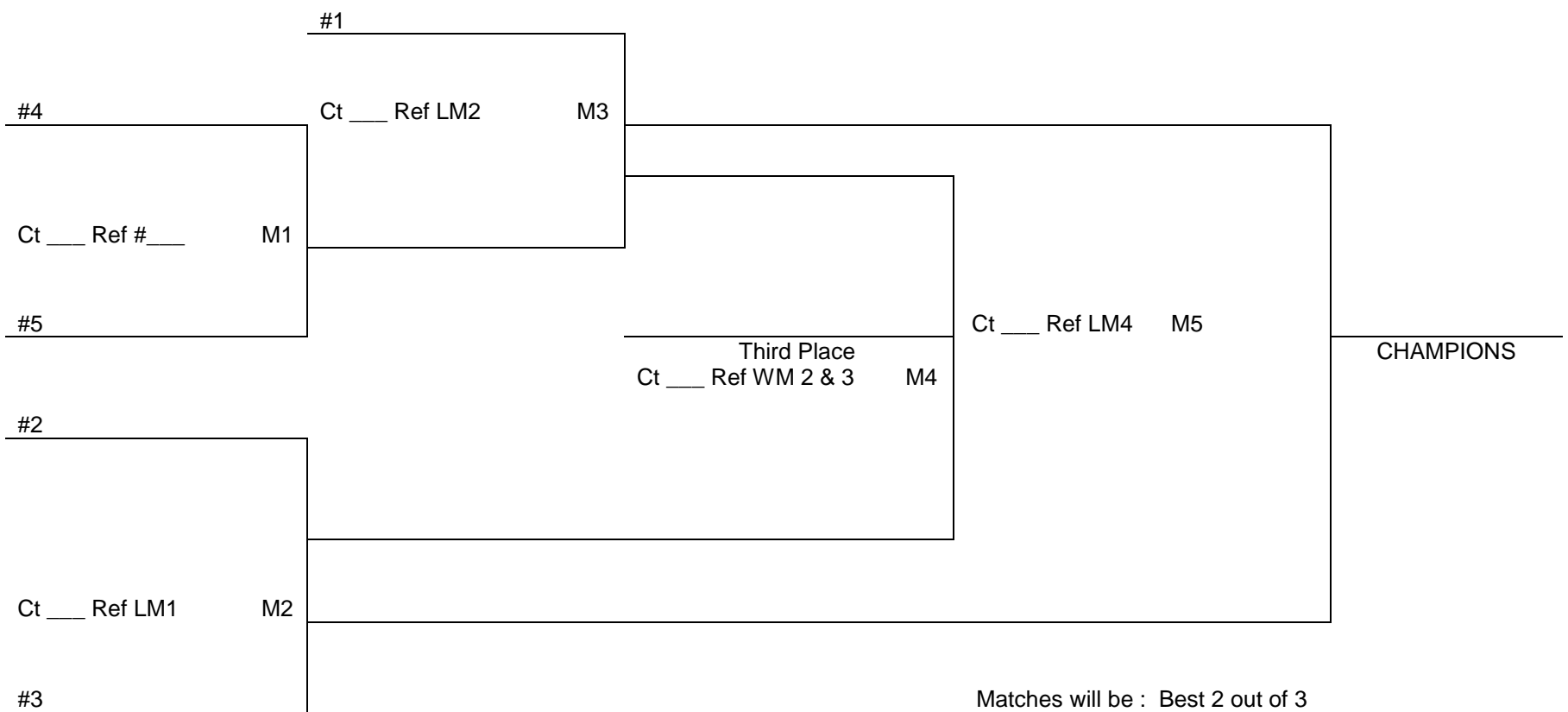

Matches will be : Best 2 out of 3  
 Sets 1&2: to 25 points  
 Set 3: to 15-switch side at 8

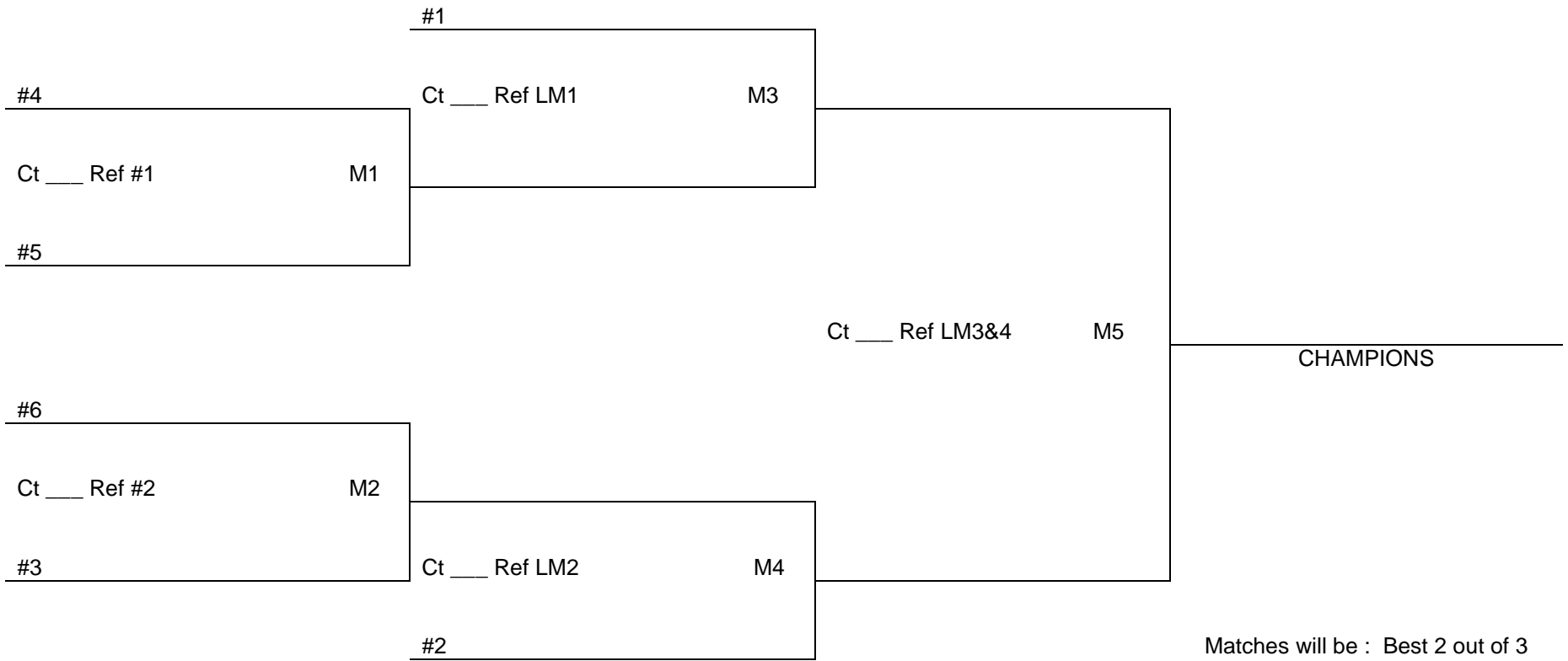

Matches will be : Best 2 out of 3  
 Sets 1&2: to 25 points  
 Set 3: to 15-switch side at 8

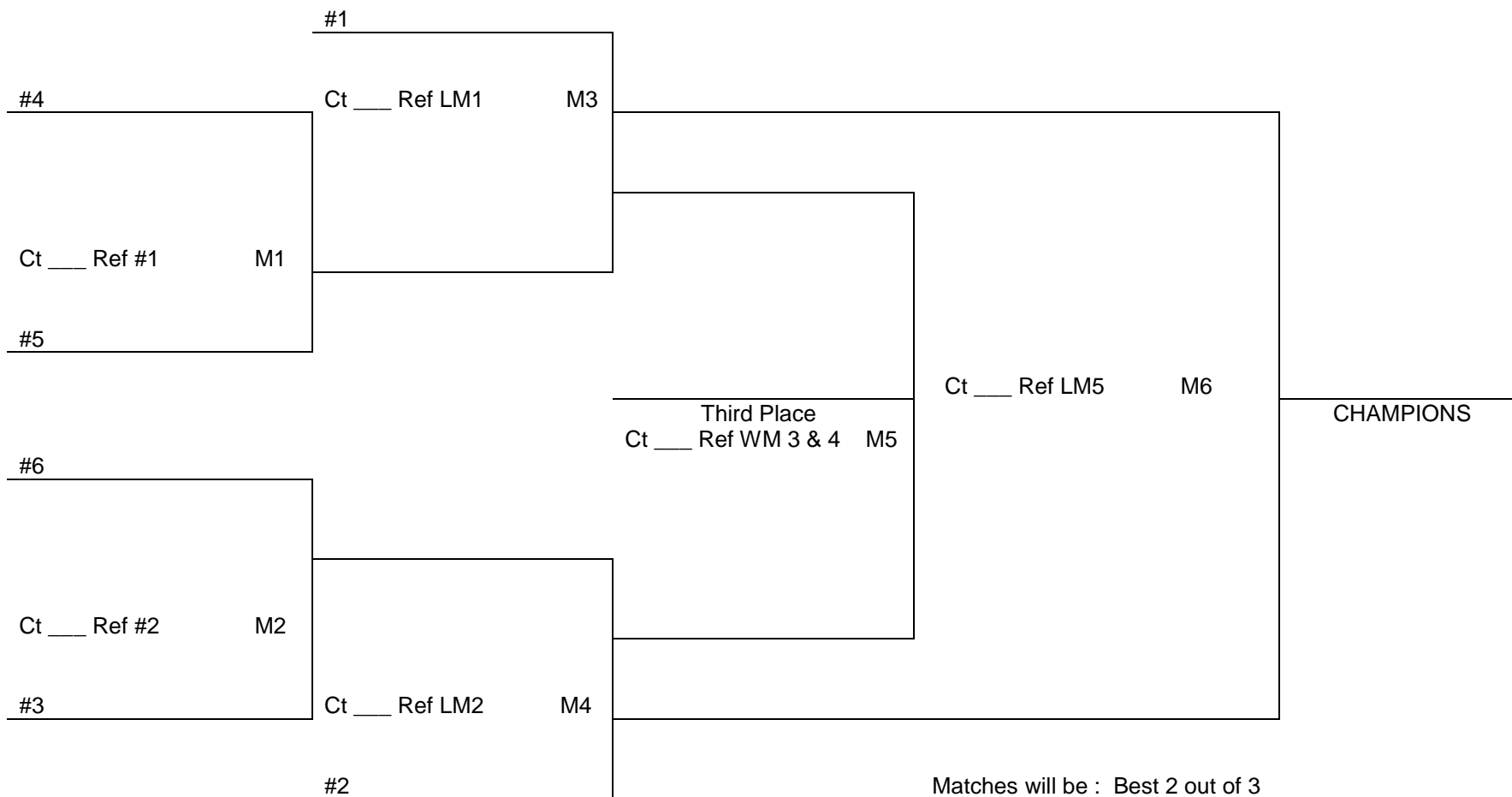

Matches will be : Best 2 out of 3  
 Sets 1&2: to 25 points  
 Set 3: to 15-switch side at 8

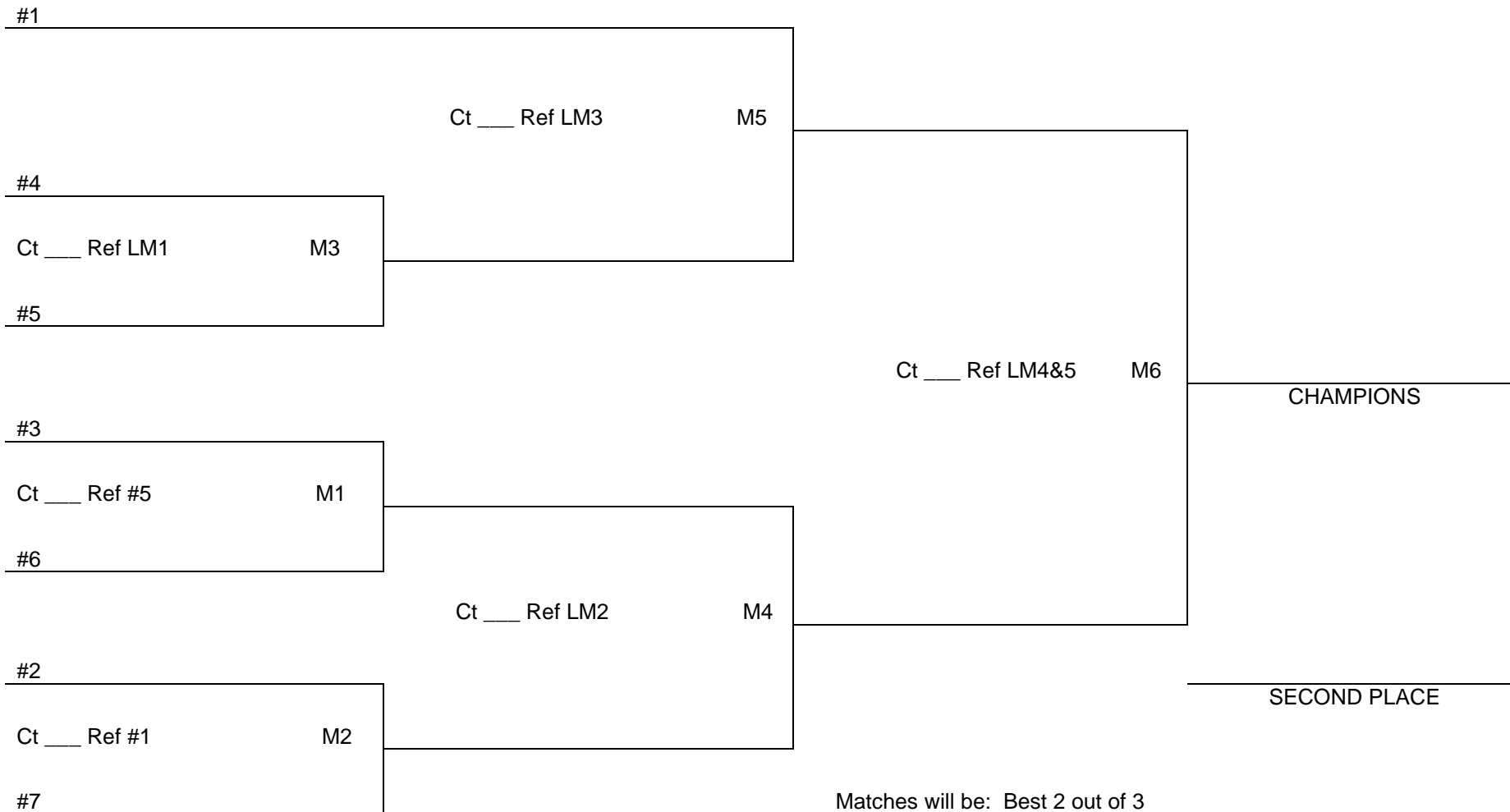

Matches will be: Best 2 out of 3  
 Sets 1&2: to 25 points  
 Set 3: to 15-switch side at 8

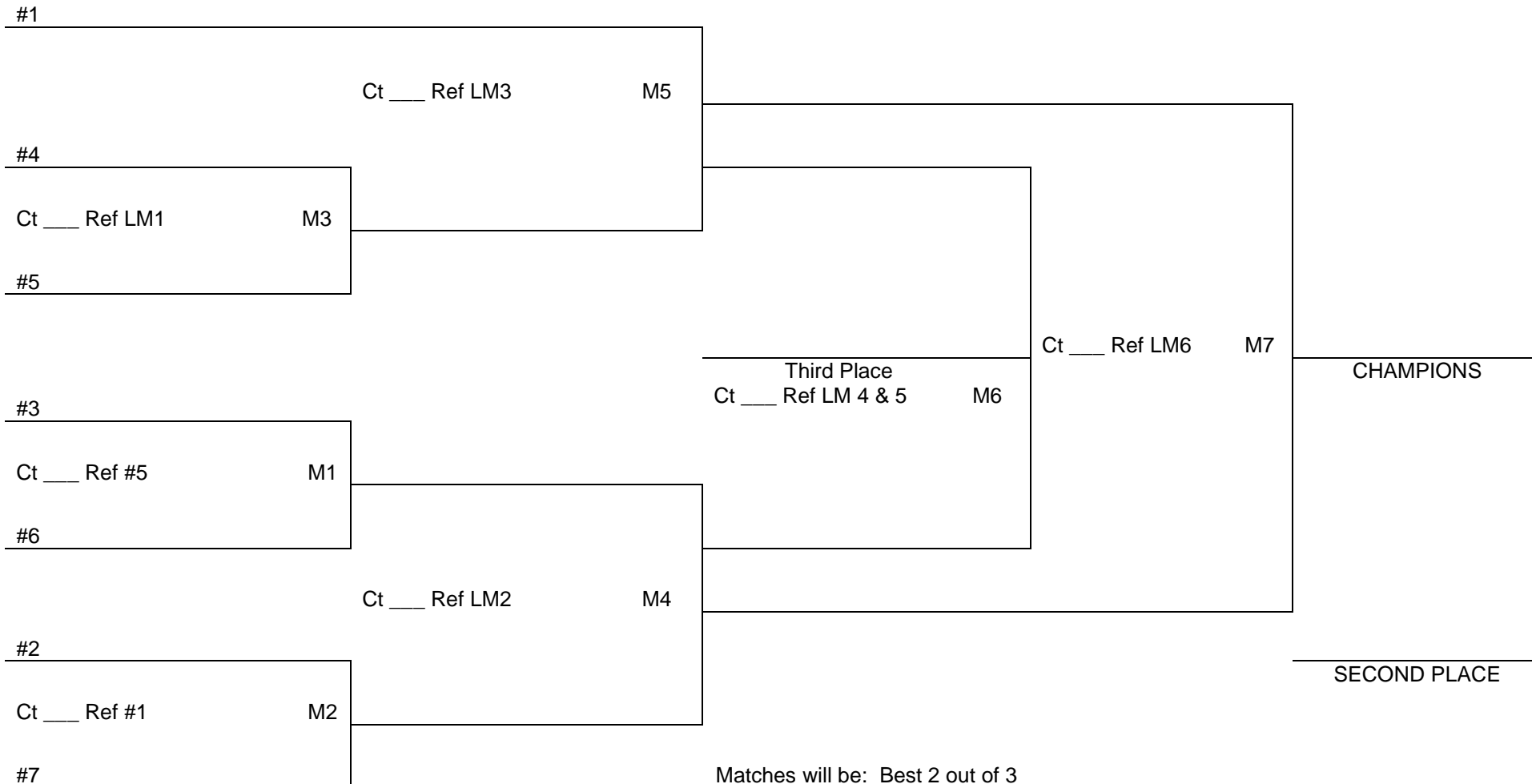

Matches will be: Best 2 out of 3  
 Sets 1&2: to 25 points  
 Set 3: to 15-switch side at 8

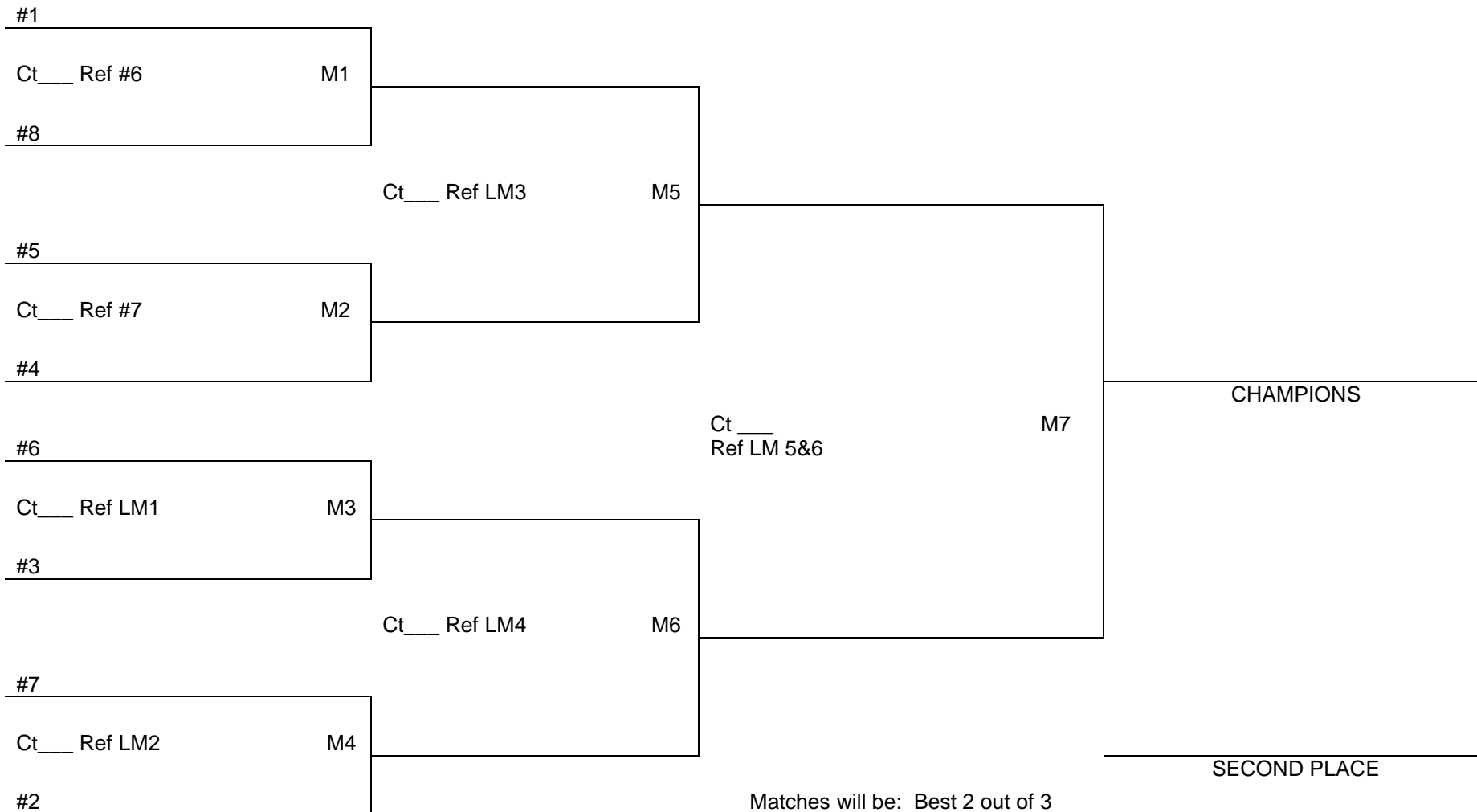

Matches will be: Best 2 out of 3  
 Sets 1&2: to 25 points  
 Set 3: to 15-switch side at 8

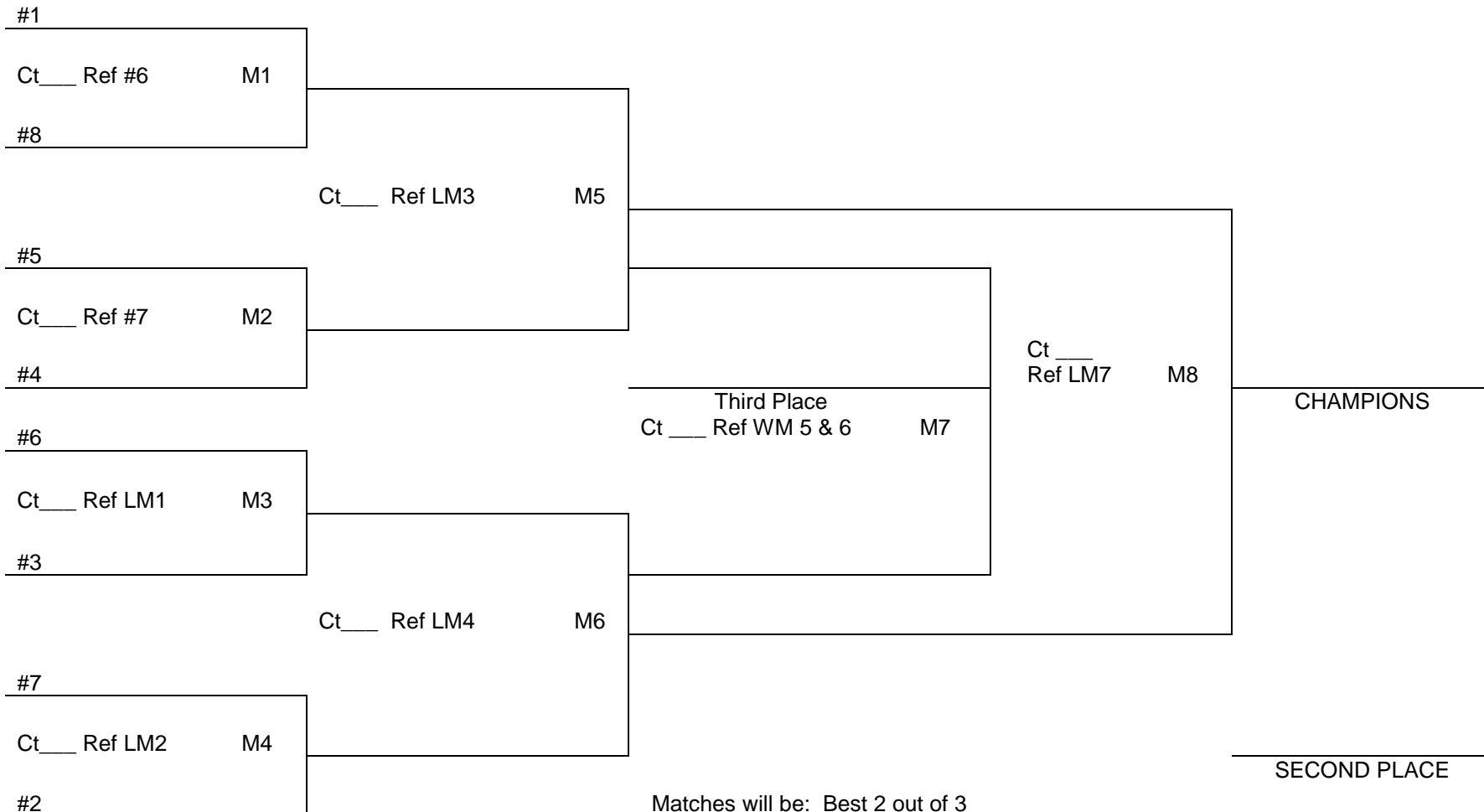

Matches will be: Best 2 out of 3  
 Sets 1&2: to 25 points  
 Set 3: to 15-switch side at 8

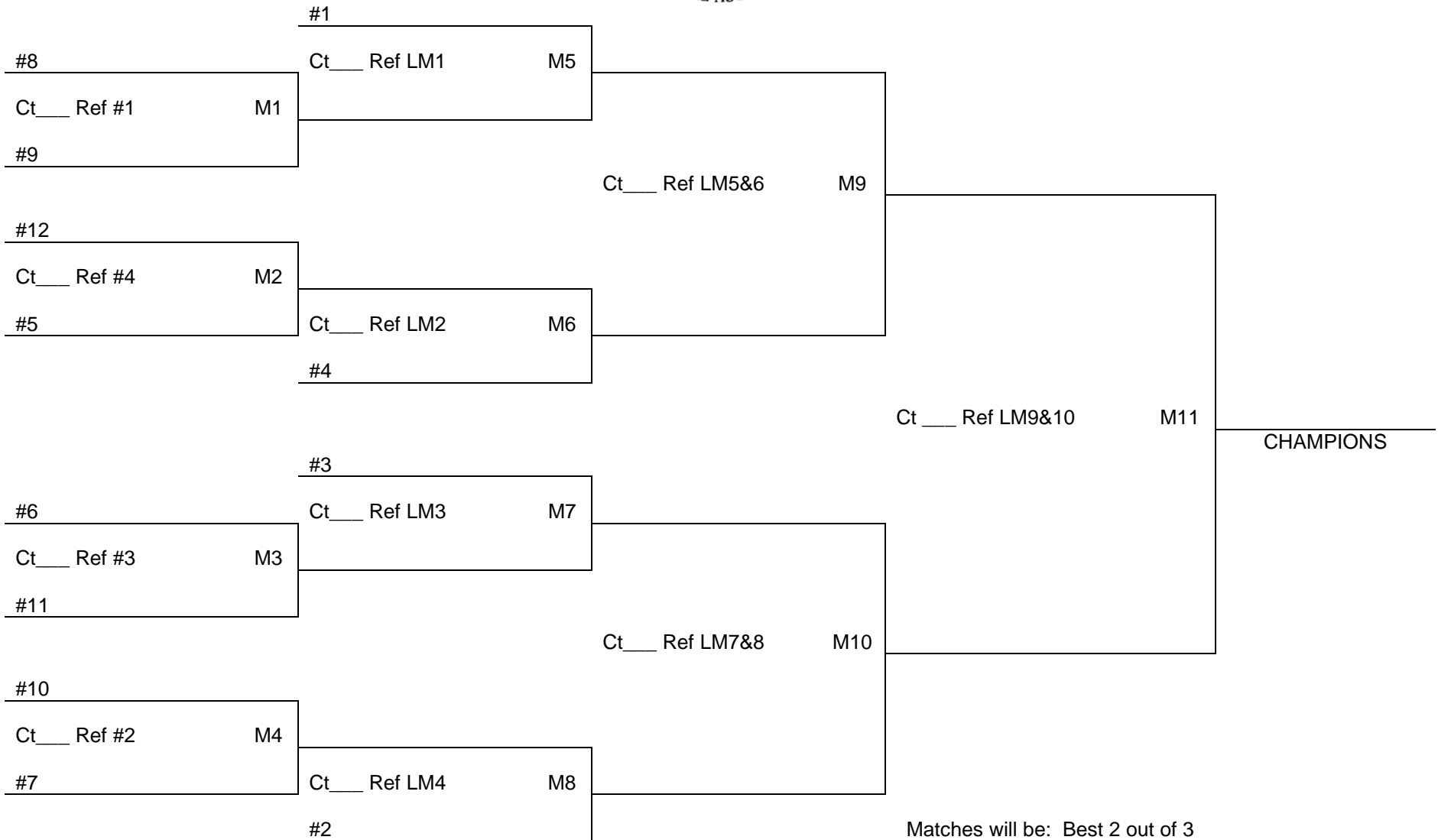

Matches will be: Best 2 out of 3  
 Sets 1&2: to 25 points  
 Set 3: to 15-switch side at 8



## Seeding Methods

**“Snake” Method: Used in formats where all teams will qualify for a playoff bracket**

Pool A	Pool B	Pool C
1. #1 Seed	1. #2 Seed	1. #3 Seed
2. #6 Seed	2. #5 Seed	2. #4 Seed
3. #7 Seed	3. #8 Seed	3. #9 Seed
4. #12 Seed	4. #11 Seed	4. #10 Seed

Example:

1. 12 Team Single Elimination.
2. Top two teams in each pool qualify for a championship or upper bracket and the bottom two teams in each pool qualify for a consolation or lower bracket.

Pool A	Pool B
1. #1 Seed	1. #2 Seed
2. #4 Seed	2. #3 Seed
3. #5 Seed	3. #6 Seed
4. #8 Seed	4. #7 Seed
5. #9 Seed	5. #10 Seed

Example:

1. 10 team single elimination
2. Top one or two teams in each pool to a playoff bracket

**“Power Pool Method”:** Used in formats where teams may be eliminated after pool play and to try to even out play amongst pools.

Pool A	Pool B	Pool C
1. #1 Seed	1. #5 Seed	1. #9 Seed
2. #2 Seed	2. #6 Seed	2. #10 Seed
3. #3 Seed	3. #7 Seed	3. #11 Seed
4. #4 Seed	4. #8 Seed	4. #12 Seed

Example:

1. All of pool A plus the top two teams in pool B to a championship bracket or upper bracket and the remainder to a consolation or lower bracket.

Pool A	Pool B	Pool C	Pool C
1. #1 Seed	1. #6 Seed	1. #7 Seed	1. #8 Seed
2. #2 Seed	2. #11 Seed	2. #10 Seed	2. #9 Seed
3. #3 Seed	3. #12 Seed	3. #13 Seed	3. #14 Seed
4. #4 Seed	4. #17 Seed	4. #16 Seed	4. #15 Seed
5. #5 Seed	5. #18 Seed	5. #19 Seed	5. #20 Seed

Note: Five team pools are not allowed by the CEVBA under normal circumstances, but by me approved on a case by case basis.

Example:

1. All of pool A plus the top team from pools B, C and D will advance to a playoff.

<u>4 Team</u>	<u>4 Team</u>	<u>4 Team</u>	<u>4 Team</u>	<u>4 Team</u>
1 vs. 4 (3)	2 vs. 3 (1)	1 vs. 3 (2)	2 vs. 4 (3)	1 vs. 4 (3)
2 vs. 3 (1)	1 vs. 4 (2)	2 vs. 4 (1)	1 vs. 3 (4)	2 vs. 3 (1)
1 vs. 3 (4)	2 vs. 4 (3)	1 vs. 4 (3)	2 vs. 3 (1)	1 vs. 3 (4)
2 vs. 4 (3)	1 vs. 3 (2)	2 vs. 3 (1)	1 vs. 4 (3)	2 vs. 4 (3)
1 vs. 2 (4)	3 vs. 4 (1)	3 vs. 4 (2)	3 vs. 4 (2)	3 vs. 4 (2)
3 vs. 4 (2)	1 vs. 2 (4)	1 vs. 2 (4)	1 vs. 2 (4)	1 vs. 2 (4)

**5 Team**

2 vs. 5 (4)	3 vs. 5 (1)
3 vs. 4 (2)	2 vs. 4 (3)
1 vs. 5 (3)	1 vs. 3 (5)
2 vs. 3 (5)	4 vs. 5 (1)
1 vs. 4 (2)	1 vs. 2 (4)

**5 Team**

2 vs. 5 (3)	4 vs. 5 (1)
1 vs. 4 (2)	2 vs. 3 (4)
3 vs. 5 (1)	1 vs. 5 (2)
2 vs. 4 (5)	3 vs. 4 (5)
1 vs. 3 (4)	1 vs. 2 (3)

**6 Team on 2 Courts**

Court 1	Court 2
4 vs. 6 (1)	3 vs. 5 (2)
1 vs. 6 (4)	2 vs. 5 (3)
1 vs. 4 (6)	2 vs. 3 (5)
4 vs. 5 (1)	3 vs. 6 (2)
30-minute lunch break	
1 vs. 5 (3)	2 vs. 6 (4)
1 vs. 3 (5)	2 vs. 4 (6)
3 vs. 4 (1)	5 vs. 6 (2)
1 vs. 2 (3)	

**7 Team on 2 Courts**

Court 1	Court 2
3 vs. 7 (6)	2 vs. 5 (1)
4 vs. 7 (5)	1 vs. 6 (2)
4 vs. 5 (7)	2 vs. 3 (6)
6 vs. 7 (4)	1 vs. 3 (2)
2 vs. 4 (7)	1 vs. 5 (3)
30-minute lunch break	
3 vs. 6 (4)	5 vs. 7 (1)
2 vs. 6 (3)	1 vs. 4 (5)
2 vs. 7 (6)	3 vs. 5 (1)
1 vs. 7 (3)	4 vs. 6 (5)
3 vs. 4 (7)	5 vs. 6 (2)
1 vs. 2 (4)	